

PostGIS 2.0 - Was bringt die neue Version?





Astrid Emde

-  WhereGroup , Bonn
- Projektumsetzung im Bereich WebGIS
- Projekte mit PostgreSQL/PostGIS, MapServer, GeoServer, Quantum GIS, Mapbender, OpenLayers
- Aktiv in **OSGeo** und **FOSSGIS e.V.**



Übersicht

- PostGIS – das Projekt
- Stand 2.0
- Was bringt die neue Version?
- Umzug auf die neue Version
- Neuerungen



Was ist PostGIS?



Was ist PostGIS?

- PostGIS ist ein räumlicher Aufsatz zur Speicherung und Verwaltung von Geodaten in PostgreSQL
- Konform mit der OGC Simple Feature Spezifikation für SQL (SFSQL)
- Orientierung an der ISO Spezifikation SQL/MM Teil 3



Es war einmal ... 2001

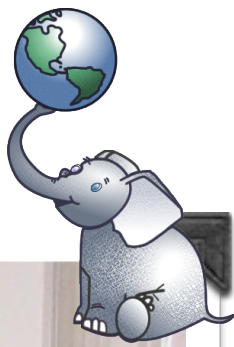

Dave Blasby

Paul Ramsey

[1]



Shapes oder besser Tabelle?

Name ▲	Type
csekani-20010412.dbf	DBF File
csekani-20010412.shp	SHP File
csekani-20010412.shx	SHX File
csekani-20010421.dbf	DBF File
csekani-20010421.shp	SHP File
csekani-20010421.shx	SHX File
haida-19991213.dbf	DBF File
haida-19991213.shp	SHP File
haida-19991213.shx	SHX File
haida-20000213.dbf	DBF File
haida-20000213.shp	SHP File
haida-20000213.shx	SHX File
haida-20010412.dbf	DBF File
haida-20010412.shp	SHP File
haida-20010412.shx	SHX File
haida-20010421.dbf	DBF File
haida-20010421.shp	SHP File
haida-20010421.shx	SHX File
klahoose-20011023.dbf	DBF File
klahoose-20011023.shp	SHP File
klahoose-20011023.shx	SHX File
klahoose-20011203.dbf	DBF File
klahoose-20011203.shp	SHP File
klahoose-20011203.shx	SHX File

Table	Date	Geometry
Haida	19991213	POLYGON()
Haida	20000213	POLYGON()
Haida	20000219	POLYGON()
Carrier	20010412	POLYGON()
Carrier	20010421	POLYGON()
Klahoose	20011023	POLYGON()

[2]

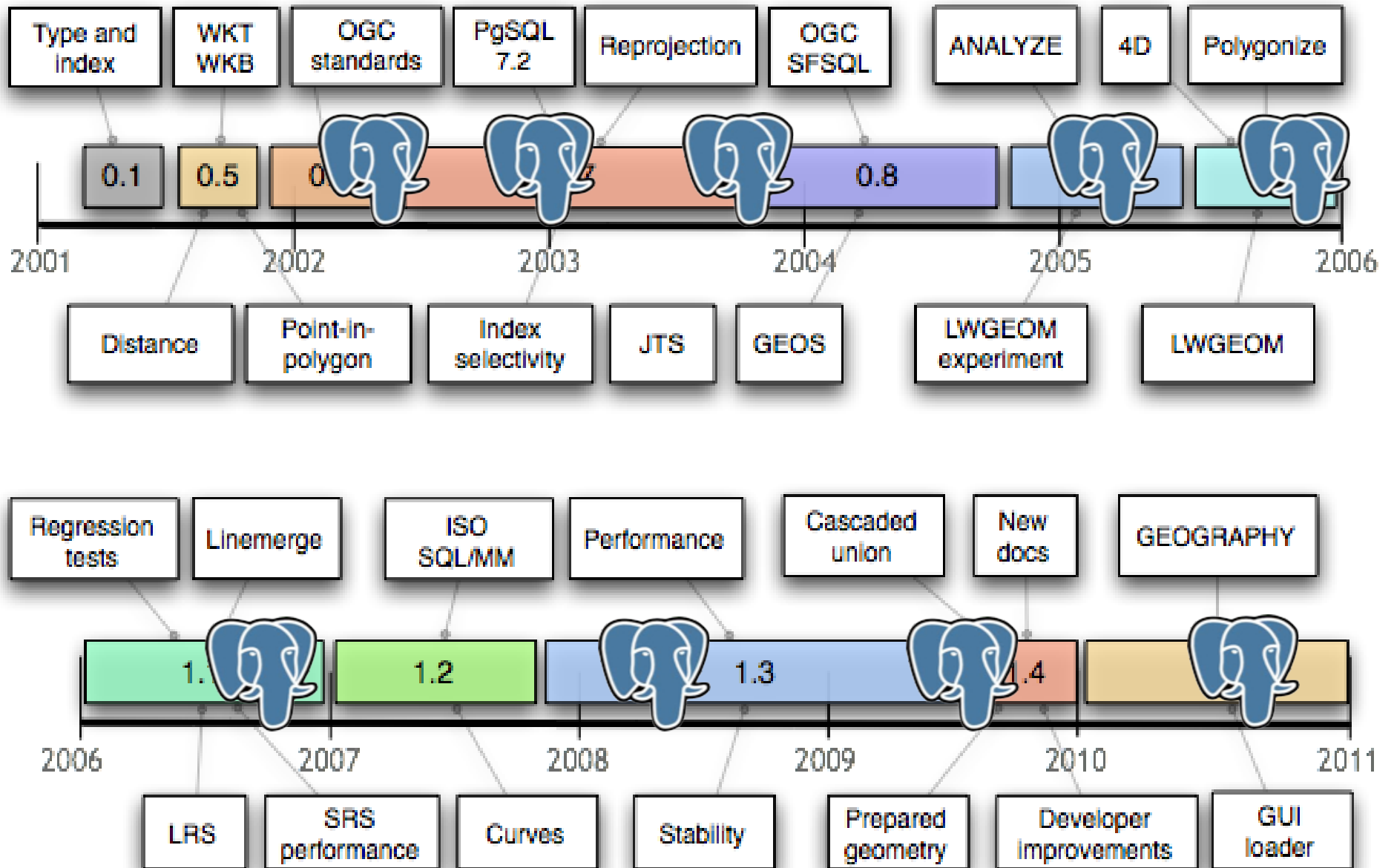



PostgreSQL

PostGIS

GEOS

PROJ4

LibXML

GDAL

[1]



Wer steckt hinter PostGIS?



Wer steckt hinter PostGIS?

- stabiles und großes Entwicklerteam
- Project Steering Committee, Chair Paul Ramsey
- Vernetzung mit anderen Projekten
- Code Sprints
- Aktive Community
- OSGeo Incubation



Wie ist der Stand von PostGIS 2.0?



PostGIS 2.0

1. Quartal 2012



Der Plan

- PostGIS 2.0beta3 (15/03/2012)
- Nur noch wenige offene Tickets
- > 900 Tickets wurden bearbeitet
- Snapshots zum Download
- Unterstützung durch Testen ist sehr willkommen

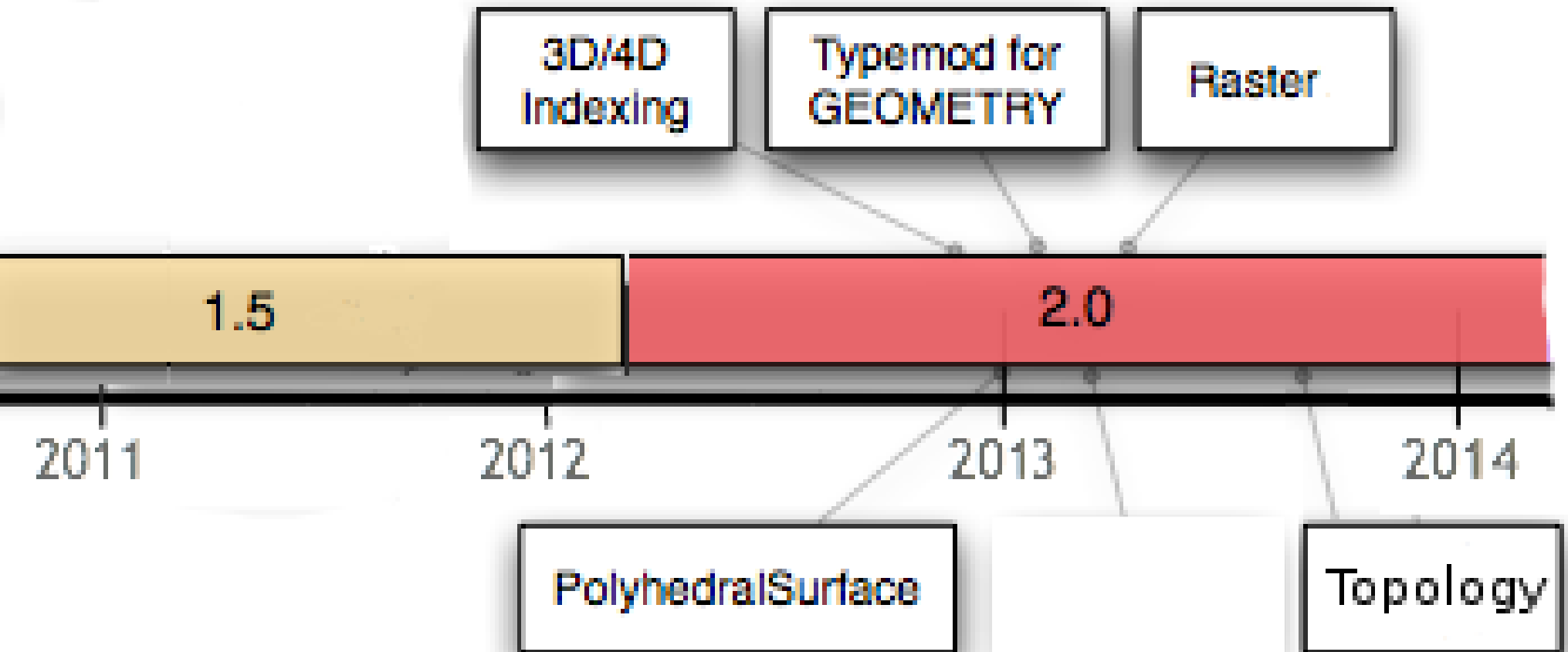

[1]



PostGIS 2.0 - Was bringt die neue Version?



PostGIS 2.0 Neuerungen

- Vereinfachte Verwaltung
- Erweiterte SQL/MM Unterstützung
- Neue Funktionen
- Rasterunterstützung
- Topology
- Erweiterte 3D Unterstützung

Was ist beim Umzug zu beachten?

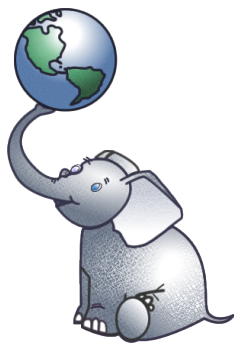

- Hard upgrade ist notwendig
- > 250 Funktionen entfallen



Hard Upgrade

- Dump/Reload
- Bereinigung mit Hilfe von `postgis_restore.pl`
- Perl-Skript entfernt alle PostGIS Definitionen



Hard Upgrade

```
pg_dump -h localhost -p 5432 -U postgres  
-Fc -b -v -f "/data/olddb.backup" olddb
```

```
createdb -h localhost -p 5432 -U  
postgres -T postgis_template newdb
```

```
perl utils/postgis_restore.pl  
"/data/olddb.backup" | psql -U postgres  
newdb 2> errors.txt
```



Funktionen entfallen

- > 250 Funktionen entfallen
- Oft ein neuer Funktionsname gemäß SQL/MM Standard
- Neuer Name ST_*
- Neuer Name ST_3D*

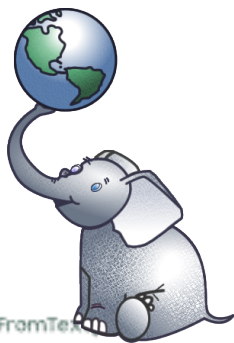

Entfallende Funktionen

IsEmpty(geometry) MLineFromText(text) rpoints(geometry) PointN(geometry,integer) PolygonFromText(text,int4) MultiPolyFromWKB(bytea) PointFromText(text,int4) MPolyFromText(text,int4)

Force_3dz(geometry) length3d(geometry) mem_size(geometry) MultiLineStringFromText(text) RotateX(geometry,float8) PointFromWKB(bytea) scale(geometry,float8,float8) st_box(box3d,geometry)

Force_3d(geometry) LineFromWKB(bytea) MPointFromText(text) nrings(geometry) PolyFromWKB(bytea,int) st_bytea(geometry)

Force_2d(geometry) LineMerge(geometry) MakePolygon(geometry) PointOnSurface(geometry) st_box3d(geometry) ST_Length(geometry)

distance(geometry,geometry) Expand(geometry,float8) length2d_spheroid(geometry,spheroid) MPolyFromText(text,int4) PolygonFromWKB(bytea,int) st_geometry(geometry)

fix_geometry_columns() InteriorRingN(geometry,integer) MultiLineFromWKB(bytea,int) PolygonFromWKB(bytea,int) st_geometry(geometry)

Expand(box3d,float8) Find_Extent(text,text,text) intersects(geometry,geometry) LineStringFromText(text,int4) relate(geometry,geometry) st_geometry(geometry)

crosses(geometry,geometry) intersection(geometry,geometry) LineFromMultiPoint(geometry) MultiPointFromWKB(bytea,int) SetPoint(geometry,integer,geometry)

Extent difference(geometry,geometry) IsSimple(geometry) MakeLine(geometry,geometry) overlaps(geometry,geometry) st_geometry(box3d) st_geometry(geometry)

Dimension(geometry) Force_Collection(geometry) hasbbox(geometry) MultiLineStringFromText(text,int4) SE_Is3D(geometry) SnapToGrid(geometry,geometry)

boundary(geometry) Dump(geometry) GeomFromWKB(bytea) max_distance(geometry,geometry) relate(geometry,geometry,text) ST_Perimeter(geometry)

hull(geometry) distance_sphere(geometry,geometry) length(geometry) LineStringFromWKB(bytea,int) PolygonFromWKB(bytea) st_geometry(geometry)

distance_spheroid(geometry,geometry,spheroid) LineFromText(text,int4) MultiPolyFromWKB(bytea,int) st_box3d(box2d) st_geometry(geometry)

Centroid(geometry) GeomCollFromWKB(bytea,int) makeline MPolyFromWKB(bytea,int) SE_M(geometry) SnapToGrid(geometry,float8)

combine_bbox(box2d,geometry) locate_between_measures(geometry,float8,float8) st_box3d_in(cstring) st_box2d(geometry)

ML(geometry) deprecated functions in PostGIS 2.0 SE_EnvelopesIntersect(geometry,geometry)

GeometryFromText(text) memcollect MultiPointFromWKB(bytea) PointFromWKB(bytea,int) ST_RemovePoint(geometry,integer)

Extent3d MemGeomUnion line_locate_point(geometry,geometry) RemovePoint(geometry,integer) SE_LocateAlong(geometry,float8) st_geometry(geometry)

Fine(geometry,float8,float8,float8,float8,float8,float8,float8,float8,float8,float8,float8,float8,float8,float8,float8,float8,float8,float8,float8) SE_LocateAlong(geometry,float8) st_geometry(geometry)

dPoint(geometry,geometry,integer) ForceRHR(geometry) locate_along_measure(geometry,float8) PolyFromText(text,int4) st_geometry(geometry)

ASEWKB(geometry) IsRing(geometry) GeometryFromText(text,int4) multi(geometry) NumPoints(geometry) SE_Z(geometry) st_geometry(geometry)

buffer(geometry,float8,integer) M(geometry) MakeBox3d(geometry,geometry) MultiPolygonFromText(text) st_box(geometry)

Area(geometry) ExteriorRing(geometry) line_interpolate_point(geometry,float8) point_inside_circle(geometry,float8,float8,float8) st_geometry(geometry)

int4) AskML(geometry,int4) DumpRings(geometry) length_spheroid(geometry,spheroid) perimeter3d(geometry) st_geometry(geometry)

AssVG(geometry,int4) Envelope(geometry) getsrid(geometry) MLineFromText(text,int4) noop(geometry) SE_LocateBetween(geometry,geometry)

ML(int4,geometry,int4) combine_bbox(box3d,geometry) IsValid(geometry) MPointFromWKB(bytea,int) probe_geometry_columns() st_geometry(geometry)

int4,int4) BdMPolyFromText(text,integer) LineFromText(text) length3d_spheroid(geometry,spheroid) MultiPointFromText(text) PolyFromText(text) Segmentize(geometry)

BuildArea(geometry) Contains(geometry,geometry) IsClosed(geometry) MakePolygon(geometry,geometry) MultiPolygonFromText(text,int4) SnapToGrid(geometry,geometry)

dPoint(geometry) collect(geometry,geometry) GeomUnion(geometry,geometry) MakePoint(float8,float8, MultiPointFromText(text,int4) SE_IsMeasured(geometry)

buffer(geometry,float8) MakeBox2d(geometry,geometry) MultiLineFromWKB(bytea,int) RotateY(geometry,float8) st_geometry(geometry)

dropbbox(geometry) GeometryN(geometry,integer) line_substring(geometry,float8, PolygonFromText(text,int4) Simplify(geometry)

Force_3dm(geometry) GeomCollFromText(text,int4) makeline_garray(geometry[]) NumInteriorRing(geometry) RotateZ(geometry,float8) st_box(geometry)

Expand(box2d,float8) GeomCollFromWKB(bytea) getbbox(geometry) MLineFromWKB(bytea,int) PointFromText(text) rename_geometry_table_constraints() st_box(geometry)

Force_4d(geometry) GeomFromWKB(bytea,int) MakePoint(float8,float8, MultiLineFromWKB(bytea) Rotate(geometry,float8) st_geometry(geometry)

Find_Extent(text,text) GeomCollFromText(text) LineFromWKB(bytea,int) MultiPointFromText(text) perimeter2d(geometry) PolygonFromWKB(bytea) reverse(geometry) st_box(geometry)

length2d(geometry) LineStringFromWKB(bytea) LineStringFromText(text) MLineFromWKB(bytea) PolyFromWKB(bytea) reverse(geometry) st_box(geometry)

MakePoint(float8,float8) MPolyFromText(text) NumInteriorRings(geometry) SnapToGrid(geometry,float8) MPointFromWKB(bytea) MPolyFromWKB(bytea) NumGeometries(geometry) MPointFromWKB(bytea)



Achtung Anpassungen!

- Views
- Eigene Funktionen, Trigger, Skripte
- DATA-Angabe MapServer Mapdatei
- Anwendungen wie MapServer, GeoServer, QGIS → Umstieg auf die neueste Version



legacy.sql



CREATE EXTENSION

- Installation von PostGIS als Erweiterung
- Ab PostgreSQL 9.1
- Mehr Flexibilität, leichter Upgrade
- PostGIS nicht mehr im Backup

```
CREATE EXTENSION postgis;
```

```
CREATE EXTENSION postgis_raster;
```

```
CREATE EXTENSION postgis_topology;
```



Geometrieverwaltung

- Geometriespalten können über Type Modifier erzeugt werden
- `geometry_columns` ist nun ein View, der aus dem Systemkatalog liest



Geometriespalten über typmod

```
CREATE TABLE poi (  
  gid serial,  
  name varchar  
  the_geom geometry (POINT, 25832)  
);
```

AddGeometryColumn use_typmod



- use_typmod – default true, Erzeugung über Type Modifier
- use_typmod false – legt Geometry über den alten Weg mit Constraints an

```
SELECT AddGeometryColumn
('public',
 'poi',
 'the_geom',
 25832,
 'POINT',
 2,
 true);
```



Registrierung von Views

```
CREATE VIEW v_buffer_poi AS
SELECT gid,
name,
ST_Buffer(the_geom, 1) :: geo
metry(Polygon, 25832)
as the_geom
FROM poi;
```



geometry_columns

```
SELECT f_table_schema,  
f_table_name, f_geometry_column,  
coord_dimension,  
srid, type  
FROM geometry_columns;
```

```
f_table_schema|f_table_name |f_geometry_column|coord_dimension | srid |type  
-----+-----+-----+-----+-----+-----  
public        | poi          | the_geom       | 2 | 25832 | POINT  
public        | v_buffer_poi | the_geom       | 2 | 25832 | POLYGON  
public        | v_buffer_poi_ohne_typmod | the_geom | 2 | 0 | GEOMETRY
```



Neue Funktionen

- ST_FlipCoordinates
- ST_Split
- ST_Snap
- ST_AsRaster
- Verbesserte SQL/MM Unterstützung



ST_FlipCoordinates

```
SELECT ST_AsText(  
  ST_FlipCoordinates(  
    ST_GeomFromText('POINT(10 50)',4326)  
  )  
);
```

st_astext

POINT(50 10)



ST_Split

```
SELECT (split).path[1],  
(split).geom::geometry(Polygon,4326) AS  
the_geom FROM (SELECT ST_Dump(ST_Split(  
ST_Buffer(ST_GeomFromText('POINT(10  
50)',4326), 5),  
ST_GeomFromText('LINESTRING(0 50,20  
50)',4326))) AS split) AS foo;
```

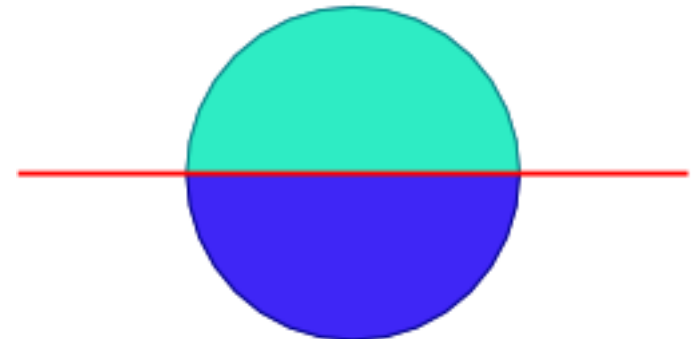
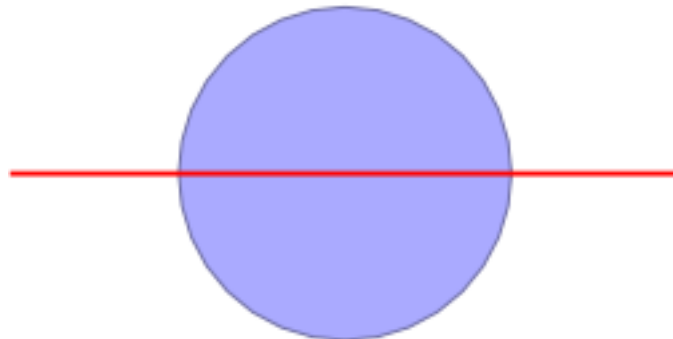



ST_Snap

```
SELECT ST_AsText(ST_Snap(poly,line,  
ST_Distance(poly,line)*1.25)) AS polysnapped FROM (SELECT  
ST_GeomFromText('MULTIPOLYGON(  
((26 125, 26 200, 126 200, 126 125,26 125 ),( 51 150, 101  
150, 76 175, 51 150 )),(( 151 100, 151 200, 176 175, 151  
100 )))') As poly,ST_GeomFromText('LINESTRING (5 107, 54  
84, 101 100)') As line) As foo;
```

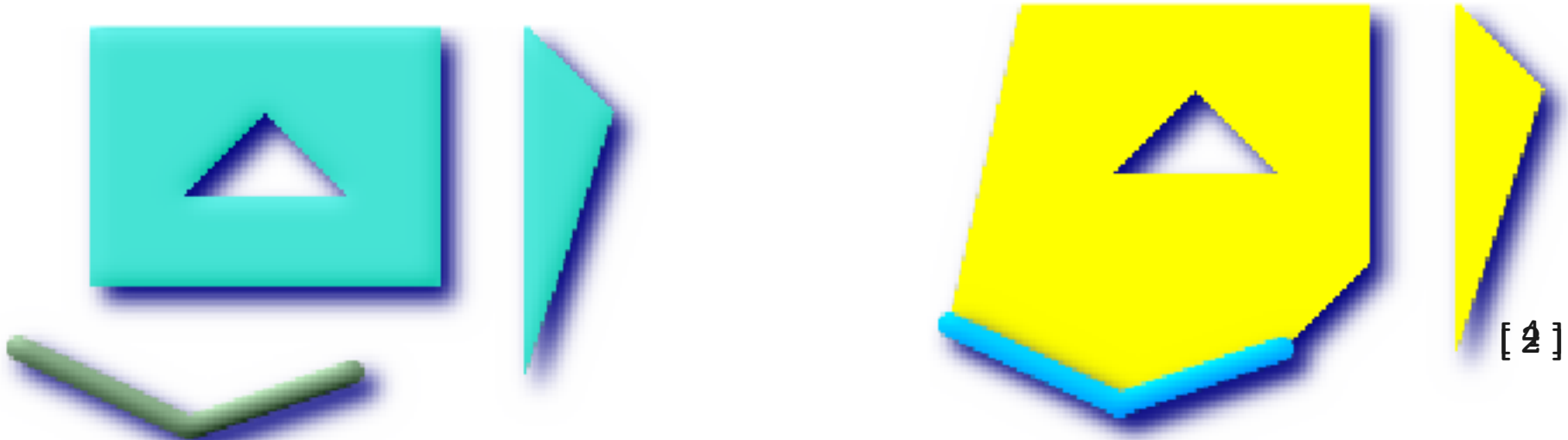



Hilfe bei der Datenbereinigung

- ST_IsValidDetail
- ab 1.5 ST_IsValidReason
- ST_MakeValid
- ST_RemoveRepeatedPoints



Invalide Polygone





ST_IsValidDetail

```
SELECT
ST_IsValidReason(the_geom) as reason,
ST_IsValidDetail(the_geom) as detail,
ST_Area(the_geom) as area
FROM invalid_polygons
WHERE
ST_IsValid(the_geom) = false;
```

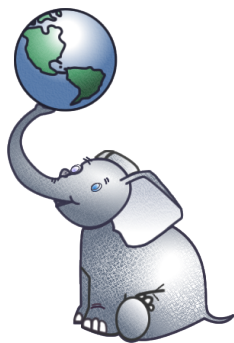

ST_IsValidDetail

reason	detail	area
Self-intersection[1 1]	(f,Self-intersection,01010000000000000000000000000000F03F00000000	0.75
0000F03F)		
Self-intersection[3 1]	(f,Self-intersection,01010000000000000000000000000000084000000000	1
0000F03F)		
Self-intersection[4.25 1]	(f,Self-intersection,01010000000000000000000000000000114000000000	0.9375
0000F03F)		
Self-intersection[6.25 1]	(f,Self-intersection,01010000000000000000000000000000194000000000	0.875
0000F03F)		
Too few points in geometry component[8 0]	(f,"Too few points in geometry	0
component",010100000000000000000000002040000000000000000)		
Valid Geometry	(t,,)	1

(6 Zeilen)





Self-intersection

POLYGON

Fläche 0.75 **falsch!**

MULTIPOLYGON

Fläche 1.25

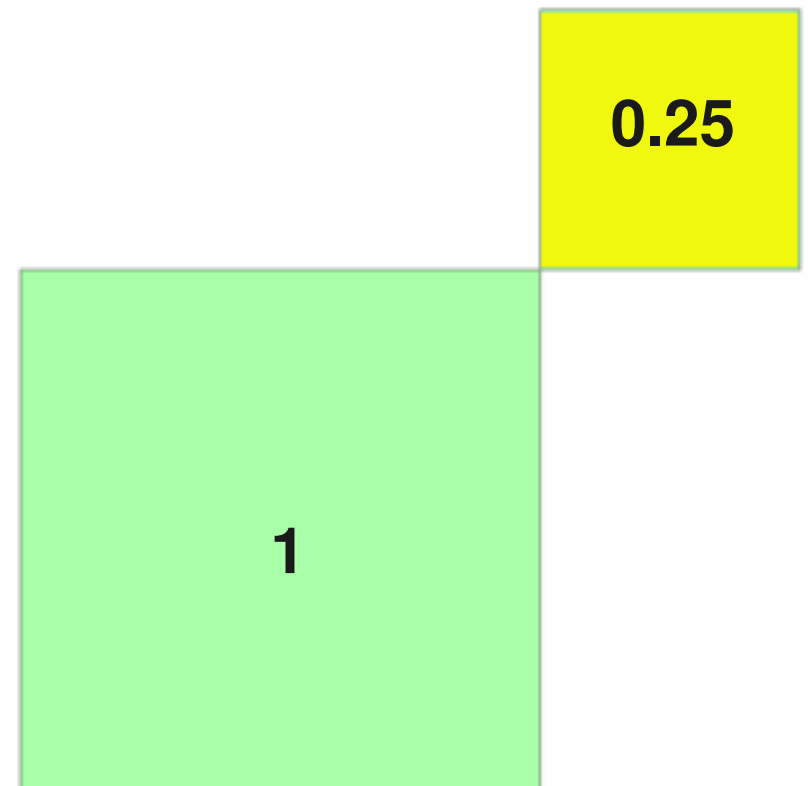
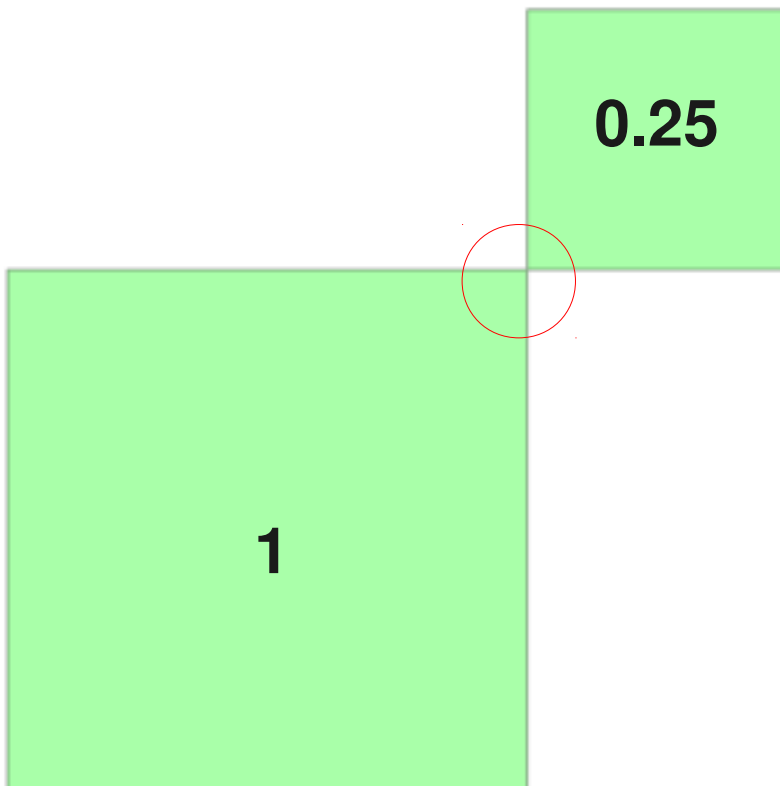



ST_MakeValid

Update invalid_polygons

set the_geom =

ST_MakeValid(the_geom)

WHERE

ST_IsValid(the_geom)=false;



Valide Polygone

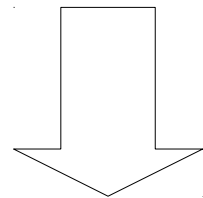
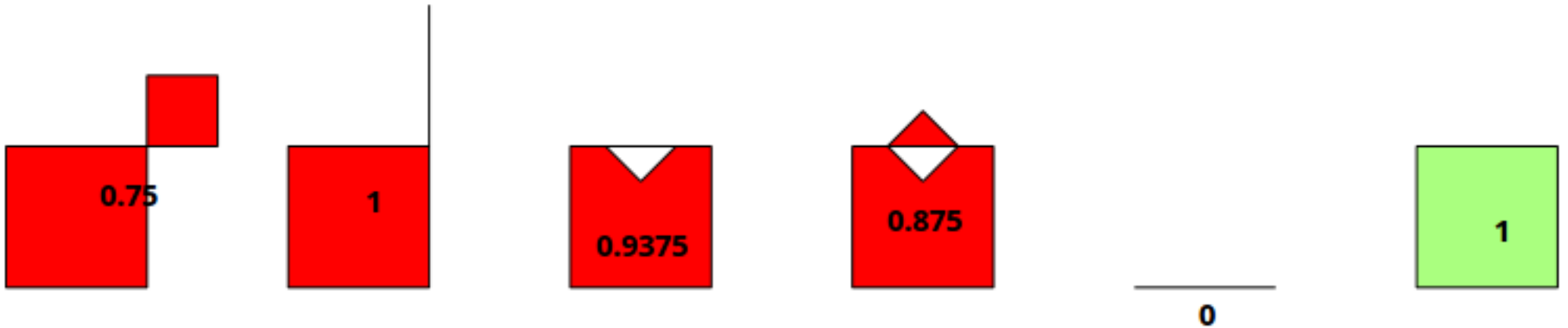

ST_MakeValid

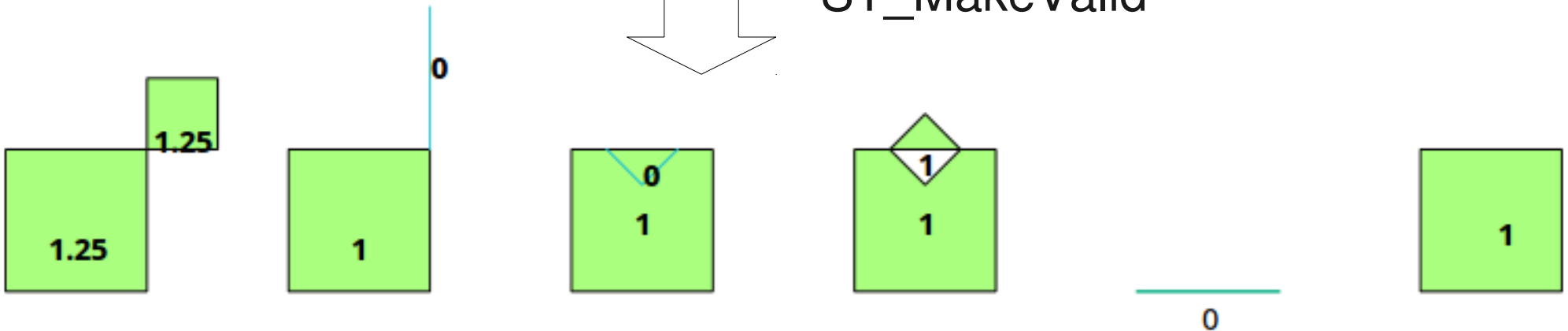



ST_RemoveRepeatedPoints

```
SELECT ST_AsText(the_geom) old,  
ST_AsText(ST_RemoveRepeatedPoints(the_geom))  
as new  
from invalid_polygons where gid=6;
```

old

```
POLYGON((10 0,10 1,11 1,11 1,11 0,10 0))
```

new

```
POLYGON((10 0,10 1,11 1,11 0,10 0))
```



ST_OffsetCurve

- Erzeugt eine parallele Linie

```
SELECT ST_OffsetCurve(  
the_geom, 2,  
'quad_segs=4 join=round')  
FROM lines;
```

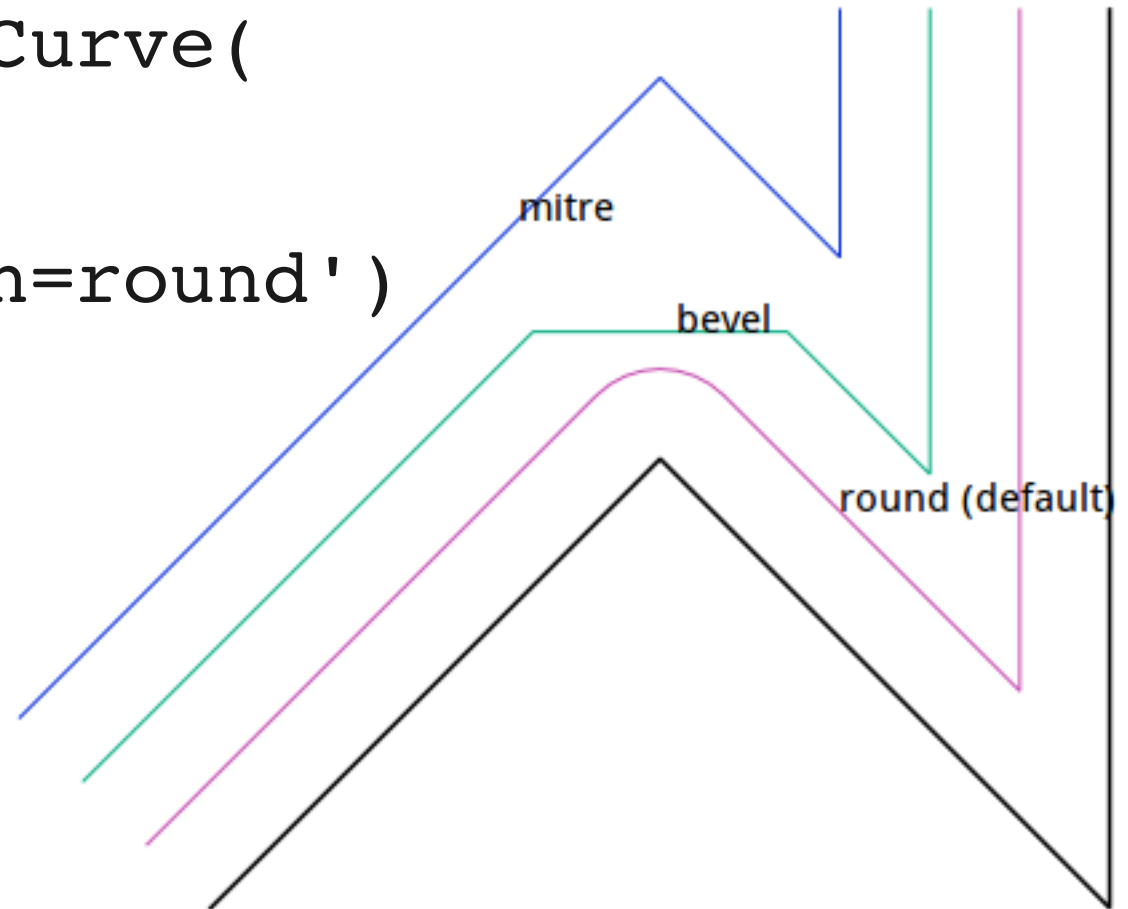

Neu!

Rasterunterstützung



- Raster Import / Export über GDAL
- > 70 Funktionen z.B. Verschneidung, Ausgabe von Pixelwerten, Statistiken, Generierung, Prozessierung
- Vektor <- -> Raster
- Raster Analyse
- Unterstützung durch GDAL 1.8+, MapServer, QGIS Plugin, gvSIG



raster2pgsql

```
raster2pgsql -s 4326 -I -C  
-M -F  
-l 4  
-t 100x100  
/user/germany/germany.tif  
germany | psql -U user -p  
5433 -d fossgis
```



Raster

- `ST_AsPNG,`
`ST_AsJPEG, ST_AsGDALRaster, ...`
- `ST_AsRaster`
- `ST_Intersects(raster, geometry)`
- `ST_PixelHeight(raster)`
- `ST_NumBands(raster)`
- `ST_Resample`
- `ST_Polygon`
- `gdal_translate`



3D

- Neue Geometrietypen
 - TRIANGLE, TIN,
POLYHEDRALSURFACE
- Neue und erweiterte Funktionen
- 3D/4D Index

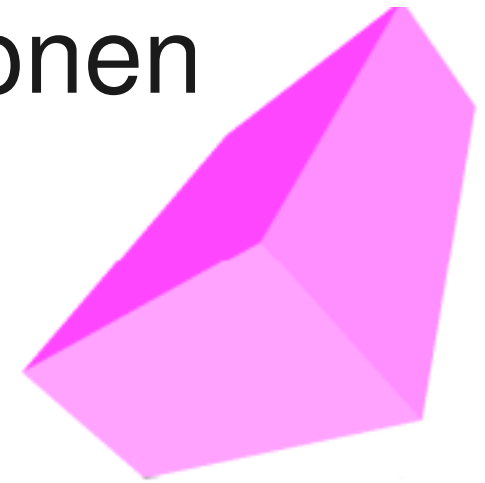



Topology

- Volle SQL/MM Topology Unterstützung
- Neuer Datentyp TopoGeometry
- Schema topology mit > 50 Funktionen
- Umwandlung in geometry über TypeCast (topo::geometry)
- Siehe [PostGIS Wiki Topology](#)

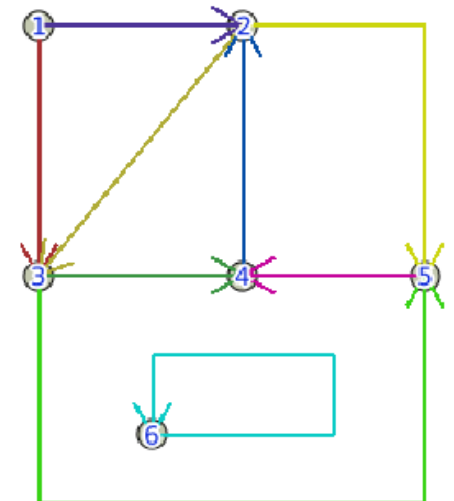



GiST KNN Suche (9.1)

- K-Nearest Neighbour Index

Beispiel: Ausgabe der 10 nächsten Objekte zu einem Punkt

```
SELECT name, gid
FROM geonames
ORDER BY geom <-> st_setsrid(st_makepoint(-
90,40),4326)
LIMIT 10;
```

<-> Distance Centroid BBOX

<#> Distance BBOX

mehr unter: [GiST KNN Suche](#)



shp2pgsql-GUI

- Plugin in pgAdmin3
- Import mehrerer Shapes

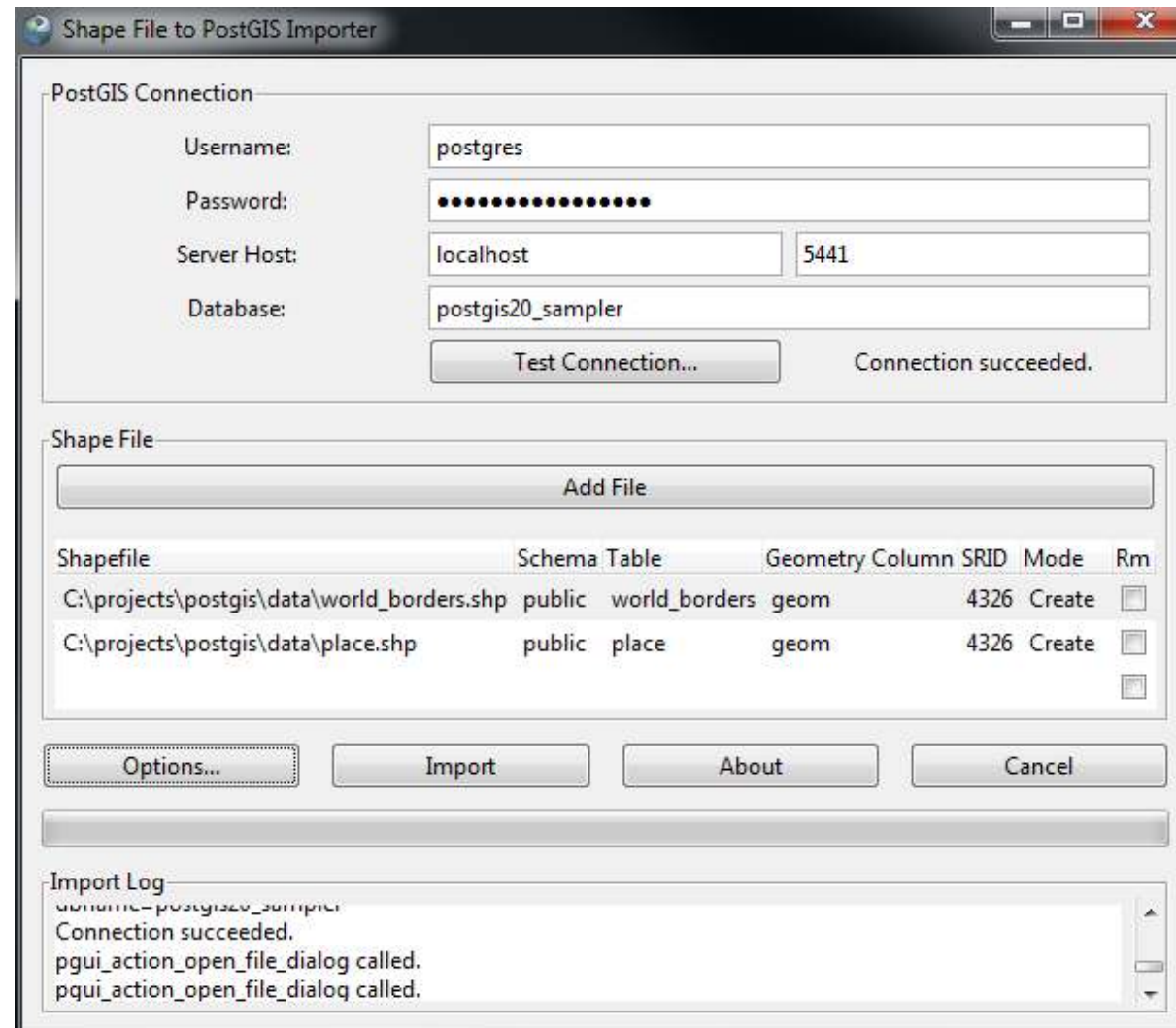

[3]



PostGIS 2.0

- und vieles mehr
- **Release Notes 2.0.0**
- **PostGIS Dokumentation: PostGIS Functions new, behavior changed, or enhanced in 2.0**
- **Milestone 2.0 (closed Tickets)**

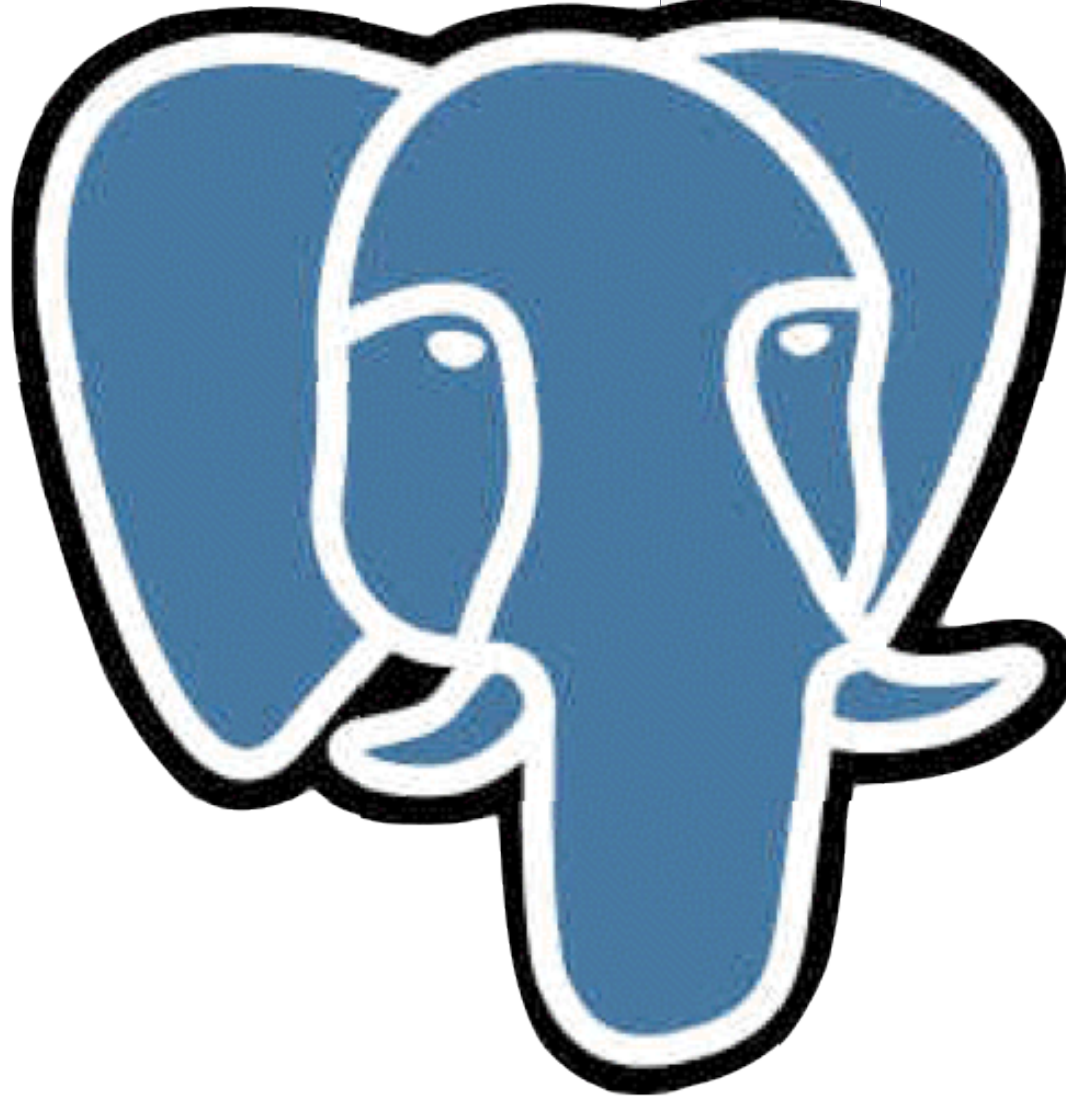

Vielen Dank!

[1]



PostGIS Dokumentation

- Sehr gute und ausführliche Dokumentation mit SQL-Beispielen und Grafiken
- HTML oder PDF-Version
- <http://postgis.org/documentation/>
- **PostGIS Wiki** (Tutorials, Präsentationen, Videos)



PostGIS in Action

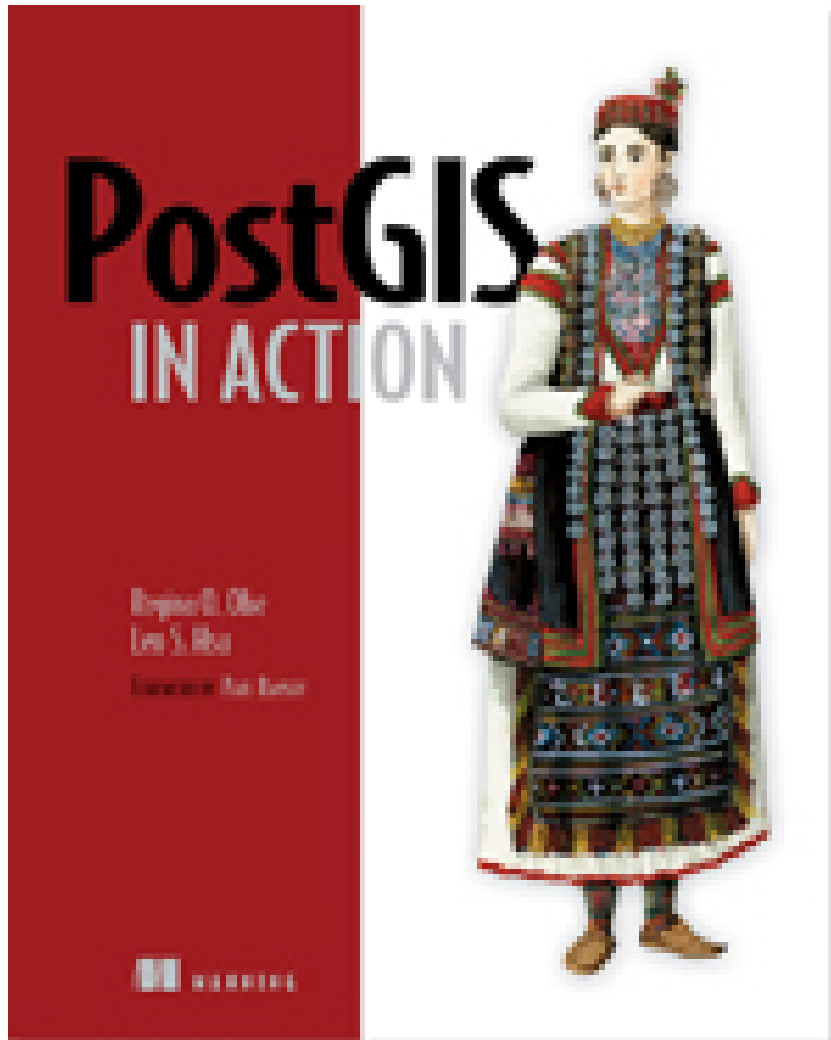

<http://www.manning.com/obe/>

Regina O. Obe und Leo S.
Hsu

Vorwort Paul Ramsey

April 2011, 520 Seiten

ISBN 9781935182269

PostGIS auf



- <http://live.osgeo.org>
- **PostGIS 1.5 auf OSGeo-Live 5.5**
- GIS Software Kollektion
- 50 Open Source GIS Anwendungen
- Beispieldaten
- Dokumentationen
- Basiert auf Xubuntu
- Bootfähige DVD, USB-Stick oder virtuelle Maschine
- ISO zum Download unter <http://live.osgeo.org/de/download.html>



Konferenzen

- FOSS4G 2012, Peking
- FOSSGIS 2012, Dessau
- FOSS4G-CC & Geoinformatics, Prag
- PG.Conf, SoTM, AGIT, INTERGEO, LinuxTag ...



Quellen

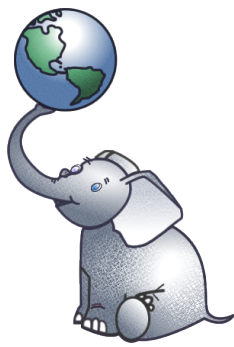

- [1] Paul Ramsey
PostGIS Knows Where You Are (PGCon 2011, Ottawa)
- [2] Paul Ramsey
The State of PostGIS (FOSS4G 2011)
- [3] Regina Obe und Leo Hsu
PostGIS 2.0 the new stuff (FOSS4G 2011, Denver)
- [4] PostGIS Documentation <http://postgis.org>
- Weitere Präsentationen und Videos im PostGIS Wiki
<http://trac.osgeo.org/postgis/wiki/UsersWikiMain>



Vielen Dank !

Fragen?

Astrid Emde

WhereGroup, Bonn

astrid.emde@wherereggroup.com